

# ProStar™

## Solar Charging System Controller

### Installation, Operation, and Maintenance Manual

For the most recent manual revision, see the version at: [www.morningstarcorp.com](http://www.morningstarcorp.com)



World's Leading Solar Controllers & Inverters

[www.morningstarcorp.com](http://www.morningstarcorp.com)

#### MODELS

---

PS-15

PS-30

PS-15M

PS-30M

Simple Network Management Protocol



## DIMENSIONS [inches (millimeters)]

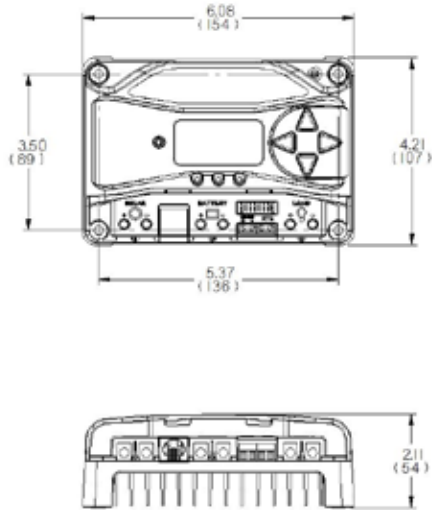

SPECIFICATION SUMMARY		
	PS-15 / PS-15M	PS-30 / PS-30M
Nominal Battery voltage	12 / 24V	12 / 24V
Max. PV Open- Circuit Voltage*	30 / 60V	30 / 60V
Max. Battery Charging Current	15A	30A
Rated Load Current	15A	30A

\*Array voltage should never exceed this limit

## TABLE OF CONTENTS

<b>1.0 Important Safety Instructions.....</b>	<b>1</b>
<b>2.0 General Information.....</b>	<b>6</b>
2.1 Overview.....	6
2.2 Regulatory Information.....	7
2.3 Features.....	9
2.4 Optional Accessories.....	11
<b>3.0 Installation.....</b>	<b>14</b>
3.1 General Installation Notes.....	14
3.2 Configuration.....	16
3.3 Mounting.....	19
3.4 Wiring.....	21
<b>4.0 Operation.....</b>	<b>31</b>
4.1 Battery Charging Information.....	31
4.2 Load Control Information.....	43
4.3 LED Indications.....	45
4.3.1 Power-up.....	45
4.3.2 Status LED.....	45
4.3.3 State-of-charge LEDs.....	46
4.4 Push-button Use in Non-Metered Versions.....	47
4.5 Custom Settings.....	48
4.5.1 Programming with Meter Display.....	48
4.5.2 Programming in MSView.....	50

Continued

## TABLE OF CONTENTS (Cont.)

4.5.3	Meter Display Operation.....	50
4.5.3.1	Directional Key Use and Operation / Navigating the Meter Map.....	50
4.5.3.2	Adjusting the Meter Display.....	51
4.5.4	Using the Meter Display to Program Charging Set-points, Load Control, Communications, and Advanced Settings.....	51
4.5.5	Lighting Control - Programming Overview.....	51
4.5.6	Lighting Programming Using Meter Display....	52
4.5.7	Low Temperature Foldback.....	53
4.6	Inspection and Maintenance.....	54
<b>5.0</b>	<b>Troubleshooting.....</b>	<b>56</b>
5.1	Alarms.....	56
5.2	LED Fault Indications.....	57
5.3	Battery Charging and Performance Issues.....	62
<b>6.0</b>	<b>Warranty and Policies.....</b>	<b>64</b>
<b>7.0</b>	<b>Technical Specifications.....</b>	<b>68</b>
<b>Appendix A - De-rating.....</b>		<b>72</b>
<b>Appendix B - Wire Sizing.....</b>		<b>73</b>
<b>Appendix C - Certifications.....</b>		<b>74</b>

## 1.0 IMPORTANT SAFETY INSTRUCTIONS

### SAVE THESE INSTRUCTIONS.

This manual contains important safety, installation, operating and maintenance instructions for the ProStar solar charge controller.

The following symbols are used throughout this manual to indicate potentially dangerous conditions or mark important safety instructions:



**WARNING:** Indicates a potentially dangerous condition. Use extreme caution when performing this task.



**CAUTION:** Indicates a critical procedure for safe and proper operation of the controller.



**NOTE:** Indicates a procedure or function that is important to the safe and proper operation of the controller.

### Safety Information

- Read all of the instructions and cautions in the manual before beginning installation.
- There are no user serviceable parts inside the ProStar. Do not disassemble or attempt to repair the controller.



**WARNING: Risk Of Electrical Shock.**

*NO POWER OR ACCESSORY TERMINALS ARE ELECTRICALLY ISOLATED FROM DC INPUT, AND MAY BE ENERGIZED WITH HAZARDOUS SOLAR VOLTAGE. UNDER CERTAIN FAULT CONDITIONS, BATTERY COULD BECOME OVER-CHARGED. TEST BETWEEN ALL TERMINALS AND GROUND BEFORE TOUCHING.*

- External solar and battery disconnects are required.
- Disconnect all sources of power to the controller before installing or adjusting the ProStar.
- There are no fuses or disconnects inside the ProStar. Do not attempt to repair.

**Installation Safety Precautions**

- Mount the ProStar indoors. Prevent exposure to the elements and do not allow water to enter the controller.
- Install the ProStar in a location that prevents casual contact. The ProStar heatsink can become very hot during operation.
- Use insulated tools when working with batteries.
- Avoid wearing jewelry during installation.
- The battery bank must be comprised of batteries of same type, make, and age.
- UL/IEC 62109 certified for use in negative ground or floating systems only
- Do not smoke near the battery bank.
- Power connections must remain tight to avoid excessive heating from a loose connection.

- Use properly sized conductors and circuit interrupters.
- This charge controller is to be connected to DC circuits only. These DC connections are identified by the symbol below:



Direct Current Symbol

The ProStar controller must be installed by a qualified technician in accordance with the electrical regulations of the country where the product is installed.

A means of disconnecting all power supply poles must be provided. These disconnects must be incorporated in the fixed wiring.

The ProStar negative power terminals are common, and must be grounded as instructions, local codes, and regulations require.

**Battery Safety**



**WARNING:** A battery can present a risk of electrical shock or burn from large amounts of short-circuit current, fire, or explosion from vented gases. Observe proper precautions.



**WARNING: Risk of Explosion.** Proper disposal of batteries is required. Do not dispose of batteries in fire. Refer to local regulations or codes for requirements.



**CAUTION:** When replacing batteries, use properly specified number, sizes, types, and ratings based on application and system design.



**CAUTION:** Do not open or mutilate batteries. Released electrolyte is harmful to skin, and may be toxic.

Servicing of batteries should be performed, or supervised, by personnel knowledgeable about batteries, and the proper safety precautions.

- Be very careful when working with large lead-acid batteries. Wear eye protection and have fresh water available in case there is contact with the battery acid.
- Remove watches, rings, jewelry and other metal objects before working with batteries.
- Wear rubber gloves and boots
- Use tools with insulated handles and avoid placing tools or metal objects on top of batteries.
- Disconnect charging source prior to connecting or disconnecting battery terminals.
- Carefully read the battery manufacturer's instructions before installing / connecting to, or removing batteries from, the ProStar.
- Be very careful not to short circuit the cables connected to the battery.
- Have someone nearby to assist in case of an accident.

- Explosive battery gases can be present during charging. Be certain there is enough ventilation to release the gases.
- Never smoke in the battery area.
- If battery acid comes into contact with the skin, wash with soap and water. If the acid contacts the eye, flood with fresh water and get medical attention.
- Be sure the battery electrolyte level is correct before starting charging. Do not attempt to charge a frozen battery.
- Recycle the battery when it is replaced.

## 2.0 GENERAL INFORMATION

### 2.1 Overview

---

Thank you for choosing the ProStar solar charge controller.

The ProStar battery charging process has been optimized for long battery life and improved system performance. Self-diagnostics and electronic error protections prevent damage when installation mistakes or system faults occur. The controller also features eight (8) adjustable settings switches, a communication port, and terminals for remote battery temperature and voltage measurement.

Please take the time to read this operator's manual to become familiar the many benefits the ProStar can provide for your PV systems, for example:

- Rated for 12 or 24 Volt systems, and 15 or 30 Amps of charging current
- Fully protected with automatic and manual recovery
- Seven standard charging programs selectable with DIP switches
- Continuous self-testing with fault notification
- LED indications and optional meter monitoring
- Terminals sized for #6 AWG /16 mm<sup>2</sup> wire
- Includes battery voltage sense terminals
- Optional remote battery temperature sensor
- 5-year warranty (see Section 6.0)

### 2.2 Regulatory Information

---



**NOTE:** This section contains important information on regulatory requirements.

ProStar controllers comply with the following European (ENs) standards:

- Immunity: EN61000-6-2:1999
- Emissions: EN55022:1994 with A1 and A3 Class B1
- Immunity: EN 61000-4-3: 2006  
EN 61000- 4-6: 2009
- Emissions: CISPR 22: 2008

#### FCC Requirements:

This device complies with Part 15 of the FCC rules. Operation is subject to the following two conditions: (1) This device may not cause harmful interference, and, (2) this device must accept any interference received, including interference that may cause undesired operation.

Changes or modifications not expressly approved by Morningstar, for compliance, could void the user's authority to operate the equipment.



**NOTE:** This equipment has been tested and found to comply with the limits for a Class B digital device, pursuant to Part 15 of the

FCC rules. These limits are designed to provide reasonable protection against harmful interference in a residential installation. This equipment generates, uses, and can radiate radio frequency energy and, if not installed and used in accordance with the instruction manual, may cause harmful interference to radio communication. However, there is no guarantee that interference will not occur in a particular installation. If this equipment does cause harmful interference to radio or television reception, which can be determined by turning the equipment on and off, the user is encouraged to try to correct the interference by one or more of the following measures:

- Re-orient or relocate the receiving antenna.
- Increase the separation between the equipment and receiver.
- Connect the equipment into an outlet on a circuit different from that to which the receiver is connected.
- Consult the dealer, or an experienced radio/TV technician for help.

This Class B digital apparatus complies with Canadian ICES-003.

## 2.3 Features

The features of the ProStar are shown in Figures 2-1, 2.2 and 2.3 below. An explanation of each feature follows.

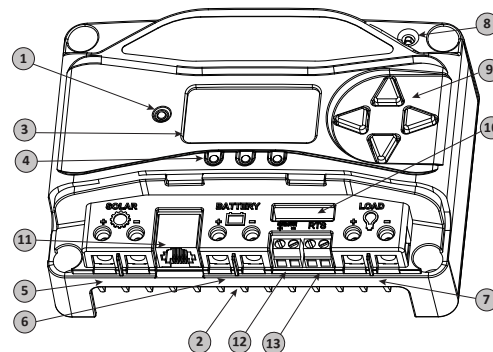

Figure 2.1. ProStar Features

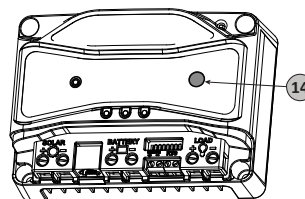

Figure 2.2. Non-Metered Unit Push-Button

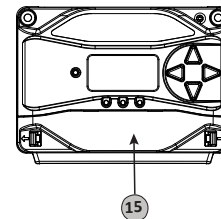

Figure 2.3. Removable Terminal Cover

### **1 - Charging Status / Error LED**

Shows charging current and error condition statuses.

### **2 - Heatsink**

Aluminum heatsink (underneath) to dissipate controller heat (the ProStar is 100% passively cooled for reliability)

### **3 - Meter Display (optional)**

Digital LCD monitoring and programming display

### **4 - Battery Status / Fault LED Indicators**

Three state of charge (SOC) LED indicators show charging status and controller faults

### **5 - Solar Positive and Negative Terminals**

Power connections for Solar (+) and (-) cable terminations

### **6 - Battery Positive and Negative Terminals**

Power connections for Battery (+) and (-) cable terminations

### **7 - Load Positive and Negative Terminals**

Power connections for Load (+) and (-) cable terminations

### **8 - Local Temperature Sensor**

Compensates charging based on ambient temperature, in absence of Remote Temperature Sensor

### **9 - Meter Directional Buttons**

Used to navigate throughout the meter map

### **10 - DIP Switches**

Eight (8) settings switches to configure operation of the ProStar

### **11 - MeterBus™ Port**

RJ-11 socket for Morningstar MeterBus™ network connections

### **12 - Battery Sense Terminals**

Connection points for battery voltage sensing wires

### **13 - Remote Temperature Sensor Terminals (RTS)**

Connection points for a Morningstar RTS to remotely monitor battery temperature

### **14 - Push-button (non-metered version)**

Initiates manual Equalization, clears any faults or reminders, conducts a lighting test, restores settings to factory default

### **15 - Removable Terminal Cover**

Cover protects circuit board and termination points

## **2.4 Optional Accessories**

The following accessories are available for purchase separately from your authorized Morningstar dealer:

### **Remote Temperature Sensor (Model: RTS)**

The RTS measures battery temperature for accurate temperature compensation and is recommended when the ambient battery temperature differs from the ambient controller temperature by +/- 5° C or more. An RTS can be attached to the ProStar at any time. The ProStar will automatically use the RTS for battery temperature compensation when installed. The standard cable length is 33 ft (10m), and can be extended to 100 ft (30m) if required. Installation instructions are provided with the RTS.





**NOTE:** *The use of a Remote Temperature Sensor (RTS) is strongly recommended.*

*Controller location, air flow, and system power can drastically affect the local temperature sensor reading. An RTS will provide optimal charging performance.*

### **RM-1 Meter**

A remote meter for monitoring system variables, for use through the ProStar Meterbus port.

### **RelayDriver (RD-1)**

The Relay Driver™ accessory enables the ProStar to control external devices. Four (4) relay control ports can be configured (in various combinations) to perform the following tasks:

- generator control (2, 3, and 4-wire configurations)
- dry contacts for alarms and other signals
- advanced load control
- vent fan control
- DIN rail compatible or surface mount

For more information on the Relay Driver, visit our website at [www.morningstarcorp.com](http://www.morningstarcorp.com), or inquire with your local Morningstar dealer.

### **Ground-fault Protection Device (GFPD-150V)**

The GFPD-150V detects power source ground faults and interrupts current as required by the US National Electrical Code.

## **Communications Support:**

### **Ethernet MeterBus Converter (EMC-1)**

This product is an Ethernet gateway that provides web monitoring services, a Modbus TCP/IP server, and a local web page server. End users can collect information about their off-grid PV system remotely. One EMC-1 supports all products with MeterBus ports by bridging MODBUS TCP/IP requests to serve LiveView pages for each product.

### **USB Communications Adapter (UMC-1)**

A modular unit that uses a USB-B plug, usually from a USB A-B computer cable, and an RJ-11 plug to connect with a Morningstar controller's MeterBus port, for monitoring and programming using MSView PC software.

### **PC MeterBus Adapter™ (Model: MSC)**

The MSC converts the MeterBus RJ-11 electrical interface to an isolated standard RS-232 interface which enables communication between the ProStar and a PC. The MSC can be used for programming custom charging set-points, and for logging data in MSView. See Section 4.5 for more information on programming.

## 3.0 INSTALLATION INSTRUCTIONS

### 3.1 General Installation Notes

- Read through the entire installation section first before beginning installation.
- Do not install in locations where water can enter the controller.
- Loose power connections and/or corroded wires may result in resistive connections that melt wire insulation, burn surrounding materials, or even cause fire. Ensure tight connections and use cable clamps to secure cables and prevent them from swaying in mobile applications.
- Preset charging profiles are generally designed for lead acid batteries. Custom settings can be used for varied charging requirements (see sections 3.2 and 4.5 for details). Note that some battery types may not be compatible.
- The ProStar battery connection may be wired to one battery or a bank of batteries. The following instructions refer to a singular battery, but it is implied that the battery connection can be made to either one battery or a group of batteries in a battery bank.
- The ProStar uses stainless steel fasteners, an anodized aluminum heat sink, and conformal coating to protect it from harsh conditions. However, for acceptable service life, extreme temperatures and marine environments should be avoided.

- The ProStar prevents reverse current leakage at night, so a blocking diode is not required in the system.
- The ProStar is designed to regulate ONLY solar (photovoltaic) power. Connection to any other type of power source e.g. wind turbine or generator may void the warranty. However, other power sources may be connected directly to the battery.
- The connector terminals will accept a maximum wire size of AWG #6 / 16 mm<sup>2</sup> (solid/multi-strand) or #8 AWG / 10 mm<sup>2</sup> (fine strand). Use an insulated flathead screwdriver, and torque tightly up to 35 in-lb.
- Stranded wires to be connected to the ProStar terminals should be prepared first with e.g. clamped copper heads, etc. to avoid the possibility of conductor strands coming free out of the connection screw, and possible contact with the metal enclosure.

 **WARNING:** *Solar and battery fuses or DC breakers are required in the system. These protection devices are external to the ProStar controller, and must be a maximum of 20 Amps for the ProStar-15/M, and 50 Amps for the ProStar-30/M.*

 **WARNING:** *All breakers must be properly rated for wire ampacity, which may require less than the maximum breaker sizes referenced above.*

 **WARNING:** Minimum over-current protection device interrupt ratings must be 2000A for 12V systems, and 4000A for 24V systems.

 **NOTE:** Carefully observe the LEDs after each connection. The LEDs will indicate proper polarity, and a secure connection.

### 3.2 Configuration

The DIP switch block shown in Figure 3.1 below is used to set the operating parameters for the ProStar.

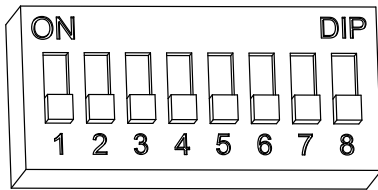

Figure 3.1. DIP Switch Block to set charging parameters

#### Switch 1: Load / Lighting

Mode	Switch 1
Normal	OFF
Lighting	ON

#### Switches 2, 3: System Voltage

Three (3) system voltage configurations are available as shown in the table below:

System voltage	Switch 2	Switch 3
Auto	OFF	OFF
12	OFF	ON
24	ON	OFF

 **NOTE:** Before connecting the battery, measure the open-circuit voltage. It must be over 10 Volts to start the controller. If the system voltage DIP Settings Switches are set to Auto-detect, battery voltage over 15.5V will be detected as a 24V nominal battery, and the unit will charge accordingly. The 12/24V auto selection is only done at start-up, and the detected system voltage will never change during operation.

It is recommended to set DIPs 2 and 3 to the correct system voltage setting. Only use the default auto-detect setting if the nominal system voltage is not known.

#### Switches 4, 5, 6: Battery Type Selection

Preset ProStar battery charging options are shown in table 3-1 below. All voltage settings listed are for nominal 12 Volt batteries. Multiply the voltage settings by two (2) for 24 Volt systems.

 **NOTE:** The charging profiles below are general guidelines for use at the operator's discretion. Consult the battery manufacturer for optimal battery charge settings.

### 3.3 Mounting

DIP Switch Settings 4-5-6	Battery Type	Absorp. Stage (-volts)	Float Stage (-volts)	Equalize Stage (volts)	Absorp. Time (mins)	Equalize Time (mins)	Equalize Timeout (mins)	Equalize Interval (days)	LVD (volts)	LVR (volts)
off-off-off	1 - Sealed*	14.00	13.50		150				11.50	12.60
off-off-on	2 - Sealed*	14.15	13.50	14.40	150	60	120	28	11.30	12.80
off-on-off	3 - Sealed*	14.30	13.50	14.60	150	60	120	28	11.50	13.00
off-on-on	4 - AGM/Flooded	14.40	13.50	15.10	180	120	180	28	11.70	13.20
on-off-off	5 - Flooded	14.60	13.50	15.30	180	120	180	28	11.90	13.40
on-off-on	6 - Flooded	14.70	13.50	15.40	180	180	240	28	12.10	13.60
on-on-off	7 - L-16	15.40	13.40	16.00	180	180	240	14	12.30	13.80
on-on-on	8 - Custom	Custom	Custom	Custom	Custom	Custom	Custom	Custom	Custom	Custom

\* "Sealed" battery type includes gel and AGM batteries

Table 3.1. Battery charging settings for each selectable battery type

#### Switch 7: Battery Equalization

Mode	Switch 7
Manual Equalization	OFF
Auto Equalization	ON

#### Switch 8: Current Switching

Mode	Switch 8
PWM switching	OFF
Slow switching	ON

The default (PWM) switching setting (OFF / down) operates at 300Hz. If load or system noise is an issue, DIP 8 can be set (ON-up) for slow switching at 1Hz. Standard PWM switching is recommended when system noise is not a problem.



**NOTE:** The heat sink must be in a vertical position (fins up and down).

For proper air flow, allow at least 15 cm (6 in) of space above and below the controller, and 50 mm (2 in) at the sides - see Figure 3-2 below. Install in an area protected from direct rain and direct sun.

If the controller is installed in an enclosure, some ventilation is recommended. Do not locate in an enclosure where battery gases can accumulate.

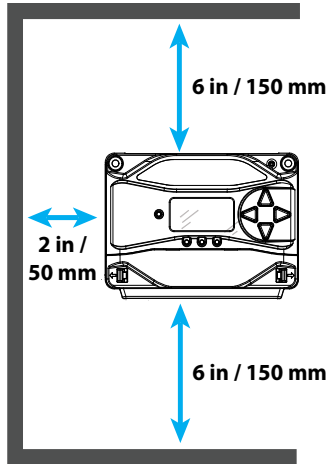

Figure 3-2. Proper Clearances for Passive Cooling

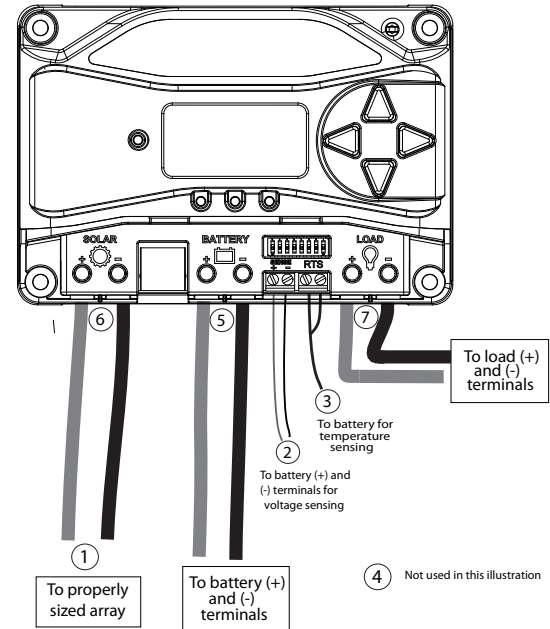

Figure 3-3. Wiring the ProStar

REFER TO FIGURE 3.3 WHEN USING THE FOLLOWING WIRING INSTRUCTIONS

## STEP 1: Check Controller Limitations

Verify that the highest temperature compensated solar array open-circuit voltage (Voc), and load current do not exceed the ratings of the ProStar version being installed.

Multiple controllers can be installed in parallel on the same battery bank to achieve greater total charging current. In this type of system, each ProStar must have its own solar array. The load terminals of multiple controllers can only be wired together if the total load draw does not exceed the nameplate current of the LOWEST rated controller.

## STEP 2: Battery Voltage Sense Wires



### **WARNING: Fire Hazard**

*When connecting Battery Sense Wires, install a 5 Amp fuse in the (+) sense wire, six inches from the (+) battery terminal.*

Due to connection and cable resistance, voltage drops are unavoidable in power cables that carry current, including the ProStar battery cables. If Battery Sense wires are not used, the controller must use the voltage reading at the battery power terminals for regulation. This voltage will be higher than the actual battery bank voltage while charging the battery.

Battery voltage Sense connection enables the ProStar to measure the battery terminal voltage precisely with small gauge wires that carry very little current, and thus have no voltage drop. The sense wires, when connected directly to the battery, will improve battery charging accuracy. Battery voltage sense wires

are recommended if the controller is more than five meters from the battery.

Generally accepted wiring practice is to limit voltage drops between the charger and the battery to 2%. Even properly sized wiring with 2% drop can result in a 0.29 Volt drop for 14.4V charging. Voltage drops will cause some undercharging of the battery. The controller will begin Absorption or limit equalization at a lower battery voltage because the controller measures a higher voltage at the controller's terminals than is the actual battery voltage. For example, if the controller is programmed to start Absorption at 14.4V, when the controller "sees" 14.4V at its battery terminals, the true battery voltage would only be 14.1V, if there is a 0.3V drop between the controller and battery.

Note that the battery sense wires will not power the controller, and the sense wires will not compensate for losses in the power wires between the controller and the battery. The battery sense wires are used to improve the accuracy of the battery charging.

The two sense wires, can range in size from 1.0 to 0.25 mm<sup>2</sup> (16 to 24 AWG), and should be cut to length as required to connect the battery to the voltage sense terminals. A 2-position terminal (see figure 3.3) is used for the battery sense connection. A twisted pair cable is recommended but not required. Use UL rated 300 Volt conductors. The voltage sense wires may be pulled through conduit with the power conductors.

Observing correct polarity, connect both battery voltage sense wires to the ProStar at the 2-position Battery Sense terminal, and to battery (+) and (-)

terminals. No damage will occur if the polarity is reversed, but the controller cannot read a reversed sense voltage.

Tighten the connector screws to 5 in-lb (0.56 Nm) of torque.

The maximum length allowed for each battery voltage sense wire is 98 ft (30m).

Connecting the voltage sense wires to the RTS terminal will cause an alarm.



**NOTE:** If the battery input voltage is greater than 5 Volts different than the *Battery Sense*, due to voltage drops or faulty connections, the *Battery Sense* input will not be recognized by the ProStar.

A battery voltage sense connection is not required to operate the ProStar controller, but it is recommended for best performance.

### STEP 3: Remote Temperature Sensor



**WARNING: Risk of Fire.**

*If no Remote Temperature Sensor (RTS) is connected, use the ProStar within 3m (10 ft) of the batteries. Internal Temperature Compensation will be used if the RTS is not connected. Use of the RTS is strongly recommended.*

All charging settings are based on 25°C (77°F). If the battery temperature varies by 5°C, the charging setting will change by 0.15 Volts for a 12 Volt battery.

This is a substantial change in the charging of the battery, and the use of the optional Remote Temperature Sensor (RTS) is recommended to adjust charging to the actual battery temperature.

The need for temperature compensation depends on the temperature variations, battery type, how the system is used, and other factors. If the battery appears to be gassing too much or not charging enough, the RTS can be added at any time after the system has been installed.

Connect the RTS to the 2-position terminal located between the battery (-) and chassis ground terminal lugs (see figure).

The RTS is supplied with 33 ft (10 m) of 22 AWG (0.34 mm<sup>2</sup>) cable. There is no polarity, so either wire (+ or -) can be connected to either screw terminal. The RTS cable may be pulled through conduit along with the power wires. Tighten the connector screws to 5 in-lb (0.56 Nm) of torque. Separate installation instructions are provided inside the RTS bag.



**CAUTION: Equipment Damage**

*Never place the temperature sensor inside a battery cell. Both the RTS and the battery will be damaged.*



**NOTE:** *The ProStar will use the local temperature sensor for compensation if the RTS is not used.*



**NOTE:** *The RTS cable may be shortened if the full length is not needed. Be sure to re-install the ferrite choke on the end of the RTS if a length of cable is removed. This choke ensures*

compliance with electromagnetic emissions standards.

#### STEP 4: Grounding

 **NOTE:** Depending on the country of installation, conductors identified by the color green, or a combination of green /yellow, shall only be used as earthing conductors.

For safety, and effective lightning protection, it is recommended, and may be locally required, that the negative conductor of the charging system be properly grounded. For conductor sizing requirements, refer to the US National Electrical Code, or applicable local regulations or code.

 **WARNING: Risk of Fire**  
DO NOT bond DC system electrical negative to earth grounding terminal on the controller. Per NEC, system negative must be bonded to earth ground at only one point, and through a GFPD if required.

#### STEP 5: Battery Connections

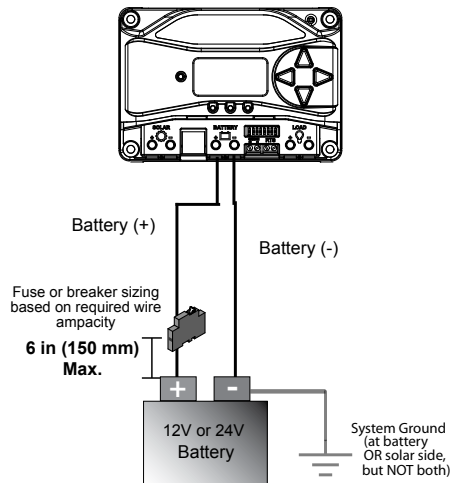

Be sure that DIP switches 2 and 3 are set for 12 or 24V, as described in Section 3.2.

 **NOTE:** Before connecting the battery, measure the open-circuit voltage. It must be over 10 Volts to start the controller. If the system voltage Settings Switches are set to Auto-detect, battery voltage over 15.5V will be detected as a 24V nominal battery, and the unit will charge accordingly. The 12/24V auto selection is only done at start-up. With the battery disconnect open, connect the battery (+) and (-) wires from the battery to controller. DO NOT CLOSE THE DISCONNECT AT THIS TIME.





### **WARNING: Shock Hazard**

The solar PV array can produce open-circuit voltages of up to 60 Vdc when in sunlight, and this DC voltage is supplied to the Power Conversion Equipment (PCE). Verify that the solar input breaker or disconnect has been opened (disconnected) before installing the system wires.

### **STEP 6: Solar Connections**

**NOTE:** For design purposes, array should be nominal 12V for 12V battery, and nominal 24V for 24V battery. Do not exceed 60Voc

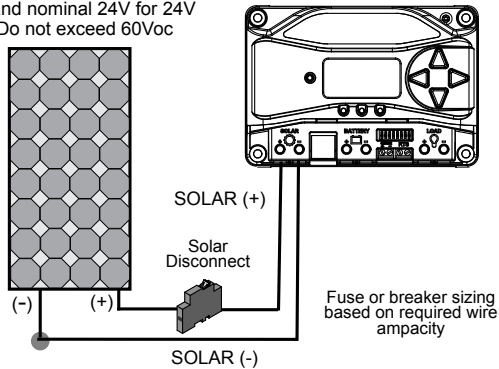

With the solar disconnect open, connect the solar (PV) array wires to the ProStar solar terminals. Use caution, since the solar array will produce current whenever in sunlight. A solar disconnect is a convenient way to break the PV connection when necessary. **DO NOT CLOSE THE DISCONNECT AT THIS TIME.**

### **STEP 7: Load Connections**



### **CAUTION: Equipment Damage**

Do not wire any AC inverter to the load terminals of the ProStar. Damage to the load control circuit may result. An inverter should be wired to the battery. If there is a possibility that any other load will sometimes exceed the Prostar's maximum voltage or current limits, the device should be wired directly to the battery or battery bank. If load control is required, contact Morningstar Tech Support for assistance.

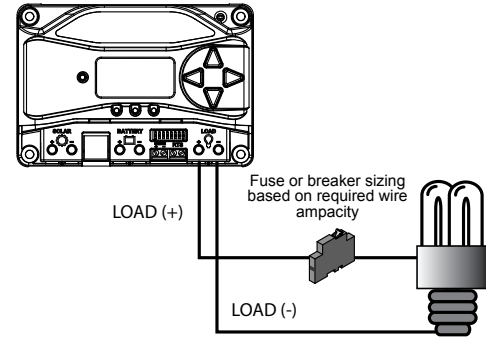

Turn the loads off, and connect the load wires to the load terminals. **DO NOT CLOSE THE FUSE OR BREAKER AT THIS TIME.**

### **STEP 8: Power-Up and Verify System Operation**

Close the battery disconnect to start the processor, and activate the controller's protections. Watch the charging status, and then the three battery state-of-charge (SOC) LEDs blink in sequence (G-Y-R),

confirming proper start-up. If they do not light, check the battery polarity (+/-) and battery voltage.

The green, yellow or red LED will light depending on the battery state-of-charge (SOC). Confirm that one of these LEDs is on before going to the next step.

Close solar disconnect. If the solar input is connected while in sunlight, the charging LED indicator will light. Confirm proper connection by observing the charging LED.

Insert the load fuse, or close the breaker, and turn the load on to confirm a proper connection. If the load does not turn on, it could be for various reasons: the ProStar is in LVD (red LED on); there is a short circuit in the load (LEDs blinking R/G - Y); there is an overload condition (LEDs blinking R/Y - G); the load is not connected, not working, or turned off. After all connections have been completed, observe the LEDs to make sure the controller is operating normally for system conditions. If the optional digital meter is used, observe that the display is scrolling with proper voltage and current values. Also, a self- test can be performed with digital meter units.

#### STEP 9: To Power Down



#### **CAUTION: Risk of Damage**

*ONLY disconnect the battery from the ProStar AFTER the solar input has been disconnected. Damage to the controller may result if the battery is removed while the ProStar is charging.*

- To prevent damage, power-down must be done in the reverse order as power-up.

## 4.0

## OPERATION

### 4.1 Battery Charging Information

#### 4-Stage Charging

The ProStar has a 4-stage battery charging algorithm for rapid, efficient, and safe battery charging. Figure 4-1 below shows the sequence of stages.

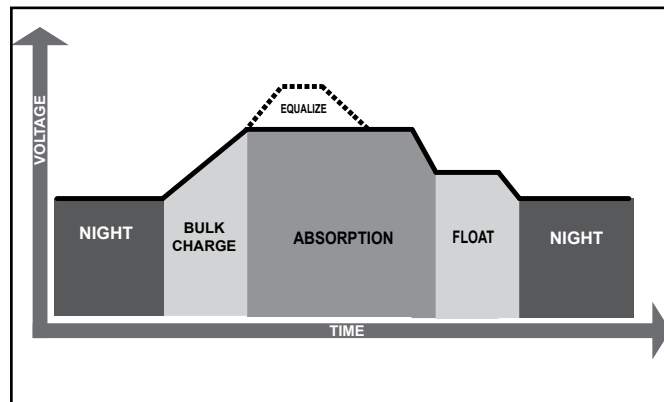

Figure 4.1. ProStar Charging Algorithm

#### Bulk Charge Stage

During Bulk charging, the battery is not at 100% state of charge and battery voltage has not yet charged to the Absorption voltage set-point. The controller will deliver 100% of available solar power to recharge the battery.

## Absorption Stage

When the battery has recharged to the Absorption voltage set-point, constant voltage regulation is used to maintain battery voltage at the Absorption set-point. This prevents heating and excessive battery gassing. The battery is allowed to come to full state of charge at the Absorption voltage set-point. The green SOC LED will blink once per second during Absorption charging. The battery must remain in the Absorption charging stage for a cumulative 150 - 180 minutes, depending on battery type, before transition to the Float stage will occur. However, Absorption time will be extended by thirty minutes if the battery discharges below 12.50 Volts (12V system) the previous night.

The Absorption set-point is temperature compensated through either the on-board local temperature sensor, or an optional Remote Temperature Sensor (RTS).

## Float Stage

After the battery is fully charged in the Absorption stage, the ProStar reduces the battery voltage to the Float voltage set-point. When the battery is fully recharged, there can be no more chemical reactions and all the charging current is turned into heat and gassing. The float stage provides a very low rate of maintenance charging while reducing the heating and gassing of a fully charged battery. The purpose of float is to protect the battery from long-term overcharge. The green SOC LED will blink once every two (2) seconds during Float charging.

Once in Float stage, loads can continue to draw power from the battery. In the event that the system load(s) exceed the solar charge current, the controller will no longer be able to maintain the battery at the Float set-point. Should the battery voltage remain below the Float set-point for a cumulative sixty minute period, the controller will exit Float stage and return to Bulk charging.

The Float set-point is temperature compensated through either the on-board local temperature sensor, or an optional Remote Temperature Sensor (RTS).

## Equalization Stage



**WARNING: Risk of Explosion**  
*Equalizing vented batteries produces explosive gases. The battery bank must be properly ventilated.*



**CAUTION: Equipment Damage**  
*Equalization increases the battery voltage to levels that may damage sensitive DC loads. Verify all system loads are rated for the temperature compensated Equalize voltage before beginning an Equalization charge.*



### **CAUTION: Equipment Damage**

*Excessive over-charging and gassing too vigorously can damage the battery plates and cause shedding of active material from the plates. An equalization that is too high, or too long, can be damaging. Review the requirements for the particular battery being used in your system.*

Certain battery types benefit from a periodic boost charge to stir the electrolyte, level the cell Voltages, and complete the chemical reactions. Equalization (EQ) charging raises the battery voltage above the standard absorption voltage so that the electrolyte gases. The green SOC LED will blink rapidly two (2) times per second during equalization charging.

The duration of the equalize charge is determined by the selected battery type. See table 4-1 in this section for more details. The Equalization Time is defined as time spent at the equalize set-point. If there is insufficient charge current to reach the equalization voltage, the equalization will terminate after an additional sixty minutes to avoid over-gassing or heating of the battery.

If the battery requires more time in equalization, with non-metered versions, manual EQ can be activated using the push-button (see Section 4.4) to continue for one or more additional EQ cycles. The ProStar meter, or MSView software, can also be used to program EQ timing and duration.

The Equalization set-point is temperature compensated through either the on-board local temperature sensor, or an optional Remote Temperature Sensor (RTS).

### **Why Equalize?**

Routine equalization cycles are often vital to the performance and life of a battery - particularly in a solar system. During battery discharge, sulfuric acid is consumed and soft lead sulfate crystals form on the plates. If the battery remains in a partially discharged condition, the soft crystals will turn into hard crystals over time. This process, called "lead sulfation", causes the crystals to become harder over time and more difficult to convert back to soft active materials. Sulfation from chronic undercharging of the battery is the leading cause of battery failures in solar systems. In addition to reducing the battery capacity, sulfate build-up is the most common cause of buckling plates and cracked grids. Deep cycle batteries are particularly susceptible to lead sulfation.

Normal charging of the battery can convert the sulfate back to the soft active material if the battery is fully recharged. However, a solar battery is seldom completely recharged, so the soft lead sulfate crystals harden over a period of time. Only a long controlled overcharge, or equalization, at a higher voltage can reverse the hardening of sulfate crystals.

### **When to Equalize?**

The ideal frequency of equalizations depends on the battery type (lead-calcium, lead-antimony, etc.), the depth of discharging, battery age, temperature, and other factors. One very broad guide is to equalize flooded batteries every one to three months or every

five to ten deep discharges. Some batteries, such as the L-16 group, will need more frequent equalizations.

The difference between the highest cell and lowest cell in a battery can also indicate the need for an equalization. Either the specific gravity or the cell voltage can be measured. The battery manufacturer can recommend the specific gravity or voltage values for your particular battery.

### Preparation for Equalization

First, confirm that all of the system loads are rated for the equalization voltage.

Consider that at 0°C (32°F) the Equalization voltage will reach 16.75 Volts for L-16 batteries with a temperature sensor installed.

Disconnect any loads at risk of damage due to the high input voltage.

If Hydrocaps are used, be sure to remove them before starting an equalization. Replace the Hydrocaps with standard battery cell caps. The Hydrocaps can get very hot during an equalization. After the equalization is finished, add distilled water to each cell to replace gassing losses. Confirm that the battery plates are submerged.

### Equalize a Sealed Battery?

The Battery Charging Settings table (see table 4-1 in this section) shows two sealed battery settings with an Equalization cycles. These are minimal "boost" cycles to level individual cells. This is not an equalization, and will not vent gas from sealed batteries that require up to 14.4V charging (12V battery).

Many VRLA batteries, including AGM and gel, have charging requirements up to 14.4V (12V battery). Depending on the battery manufacturer's recommendation, the "boost" cycle for sealed cells can be disabled by setting the equalize setting switch to manual, if required.

### Battery Charge Settings

.....

The ProStar provides seven (7) standard battery charging settings that are selected with the settings switches (see Table 4.1 above). These standard charging settings are suitable for lead-acid batteries ranging from sealed (gel, AGM, maintenance-free) to Flooded and L-16 cells. In addition, an eighth charging setting provides for custom set-points using MSView™ PC software. Table 4-1 below summarizes the major parameters of the standard charging settings. The shared settings in Table 4-2 are common to all battery types.

**NOTE:** These settings are general guidelines for use at the operator's discretion. Consult the battery manufacturer for optimal battery charge settings.

DIP Switch Settings 4-5-6	Battery Type	Absorp. Stage (volts)	Float Stage (volts)	Equalize Stage (volts)	Absorp. Time (mins)	Equalize Time (mins)	Equalize Timeout (mins)	Equalize Interval (days)	LVD (volts)	LVR (volts)
off-off-off	1 - Sealed*	14.00	13.50		150				11.50	12.60
off-off-on	2 - Sealed*	14.15	13.50	14.40	150	60	120	28	11.30	12.80
off-on-off	3 - Sealed*	14.30	13.50	14.60	150	60	120	28	11.50	13.00
off-on-on	4 - AGM/Flooded	14.40	13.50	15.10	180	120	180	28	11.70	13.20
on-off-off	5 - Flooded	14.60	13.50	15.30	180	120	180	28	11.90	13.40
on-off-on	6 - Flooded	14.70	13.50	15.40	180	180	240	28	12.10	13.60
on-on-off	7 - L-16	15.40	13.40	16.00	180	180	240	14	12.30	13.80
on-on-on	8 - Custom	Custom	Custom	Custom	Custom	Custom	Custom	Custom	Custom	Custom

\* "Sealed" battery type includes gel and AGM batteries

Table 4.1. Battery charging settings for each selectable battery type

Shared Settings	Value	Units
Absorption Extension voltage	12.50	Volts
Absorption Extension Time	Absorption Time + 30	Minutes
Float Exit Time-out	30	Minutes
Float Cancel voltage	12.10	Volts
Equalize Time-out	Equalize Time + 60	Minutes
Temperature Compensation Coefficient	- 30	Millivolts / °C / 12V

Table 4.2. Battery settings that are shared between all battery types

## Absorption Extension

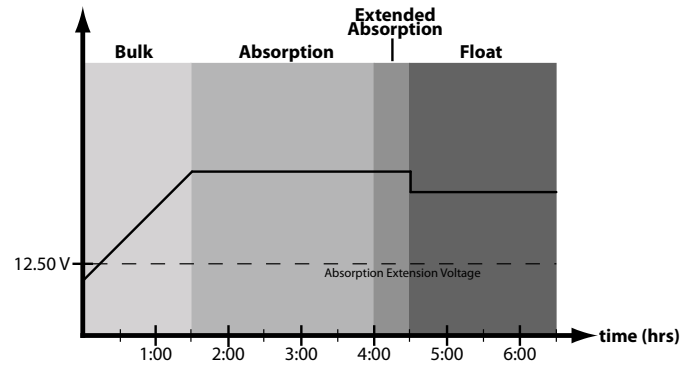

Figure 4-2. Absorption Extension Charging Profile

If battery voltage discharges below 12.50 Volts (25.00 Volts @ 24V) the previous night, Absorption charging will be extended on the next charge cycle as shown in figure 4-2 above. Thirty minutes will be added to the normal Absorption duration.

## Float Time-out

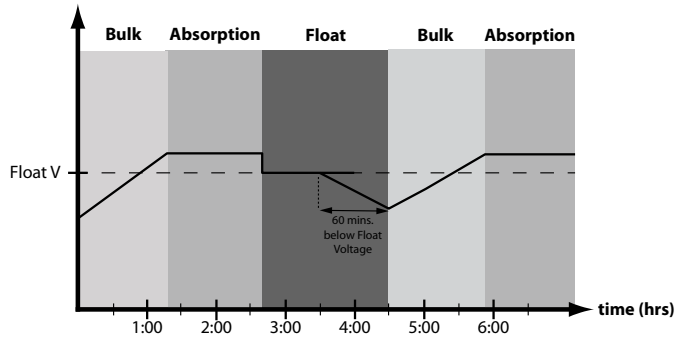

Figure 4-3. Float Exit Time-out Charging Profile

After entering Float stage, the controller will only exit Float if the battery voltage remains below Float voltage for sixty cumulative minutes. In figure 4-3, a system load turns on at 3:30 hrs when the controller is in Float stage, runs for one hour, and turns off at 4:30 hrs. The load current draw is larger than the charge current, causing battery voltage to drop below Float voltage for sixty minutes. The time-out causes the controller to return to Bulk charging, and then Absorption stage again. In this example, a load runs continuously for sixty minutes. However, because the Float exit timer is cumulative, multiple momentary load events that pull the battery voltage below Float voltage for a combined sixty minute duration will also force an exit from Float stage.

## Float Cancel voltage

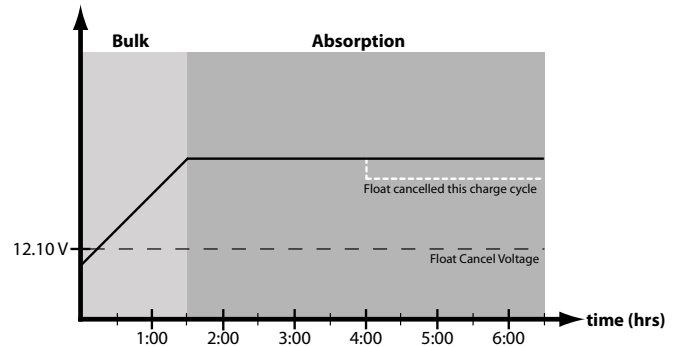

Figure 4.4. Float Cancellation Charging Profile

If the battery bank discharges below 12.10 Volts (24.20 Volts @ 24V) the previous night, Float charging stage will be cancelled for the next charge cycle. Figure 4-4 above, illustrates this concept. At 0:00 hrs (dawn), battery voltage is below the Float Cancel threshold voltage. The diagram shows where Float stage would have occurred if Float was not cancelled.

## Equalize Time-out

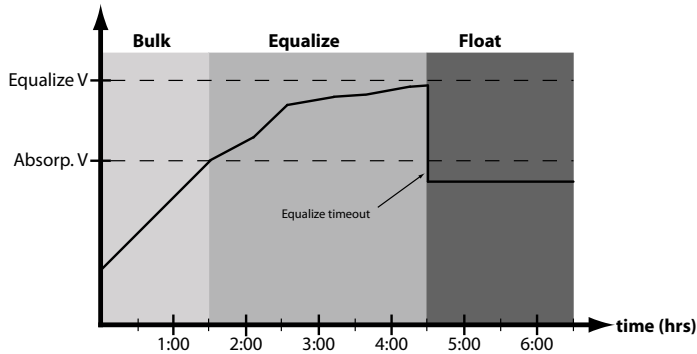

Figure 4.5. Equalize time-out charging profile

The charging profile in figure 4-5 above, shows an Equalize Time-out event. The time-out timer begins as soon as battery voltage exceeds the Absorption voltage set-point. If there is insufficient charging current or system loads are too large, the battery voltage may not reach the Equalize set-point. To avoid battery damage, The Equalize Time-out safety feature prevents high battery voltage for extended periods of time.

## 4.2 Load Control Information

The primary purpose of the load control function is to disconnect system loads when the battery has discharged to a low state of charge, and reconnect system loads when the battery is sufficiently recharged. The total current draw of all loads must not exceed the ProStar 15 or 30 Amp maximum load rating.

### Current Compensation:

All LVD and LVR set-points are current compensated. Under load, the battery voltage will sag in proportion to the current draw of the load. A short-term large load could cause a premature LVD without the current compensation feature. Current compensation begins at three Amps of load draw. LVD and LVR set-points are adjusted lower per the following table:

System voltage	Current Compensation
12 Volt	-20 mV per Amp of load
24 Volt	-40 mV per Amp of load

Table 4-3. LVD and LVR Current Compensation Values



## LVD Warning:

As the battery discharges the Battery Status LEDs will transition from green to yellow and then from yellow to flashing red. The flashing red indication is a warning that a low voltage disconnect event will occur soon.

The amount of time between a green SOC indication and load disconnect will depend on many factors including:

- rate of discharge - based on amount of load current
- capacity of the battery
- health of the battery
- LVD set-point

If the battery discharges to the LVD set-point the load will disconnect and a solid red Battery Status LED indication will be displayed.

## General Load Control Notes:

Do not wire multiple ProStar load outputs together in parallel to power DC loads with a current draw greater than 15 or 30A, depending on the ProStar model. Equal current sharing cannot be assured and an over-load condition will likely occur on one or more controllers.

Exercise caution when connecting loads with specific polarity to a live load circuit. A reverse polarity connection may damage the load. Always double check load connections before applying power.

## 4.3 LED Indications

---

### KEY:

G = green	G - Y - R = flashing sequentially
Y = yellow	G / Y = flashing together
R = red	G / Y - R = G and Y flashing together, alternating with R flash

### 4.3.1. Power-up

Normal power-up: Status LED flashes **G**, then SOC LEDs flash **G - Y - R**, then SOC LEDs indicate battery charge status with a single battery status LED.

Failed bootload: Status LED flashes **G**, then SOC LEDs flash **G - Y** and stop on solid **Y**.

### 4.3.2 Status LED

The Status LED indicates charging status and any existing solar input error conditions. The Status LED is on when charging during the day and off at night. The Status LED will flash red whenever an error condition(s) exists. Table 4.4 below, lists the Status LED indications.

Color	Indication	Operating State
None	Off (with heartbeat <sup>1</sup> )	Night
Green	On Solid (with heartbeat <sup>2</sup> )	Charging
Red	Flashing	Error
Red	On Solid (with heartbeat <sup>2</sup> )	Critical Error

<sup>1</sup> heartbeat indication flickers the Status LED on briefly every 5 seconds

<sup>2</sup> heartbeat indication flickers the Status LED off briefly every 5 seconds

Table 4.4. Status LED Definitions

#### NOTES:

- 1) R flashing is generally a user addressable fault / error
- 2) R charging status LED ON with heartbeat blink OFF every 5 secs is a critical fault that generally requires service. See, "Solid Charging Status LED with Self-test (R-Y-G) SOC Faults", in Section 5.2.

#### 4.3.3 State-of-Charge LEDs

Battery SOC LED Indications are shown in Table 4-3 below:

Condition	Indication
Absorption	G flash - every sec
Float	G flash - every 2 secs
Equalize	G flash - 2 / sec
SOC > 13.5V	G solid
13.5V > SOC > 13.0V	G / Y solid
13.0V > SOC > 12.5V	Y solid
SOC < 12.5V	Y / R solid
Low voltage disconnect warning	R flash - every sec
Low voltage disconnect	R solid

Table 4.5. Battery SOC LED Indications

### **4.4 Push-Button Use in Non-Metered Versions**

The non-metered version of the ProStar features a push-button that operates as follows depending on the DIP Switch 1 setting:

Normal Mode (DIP 1 OFF), (Operation effective with Firmware v6.0)

One quick press and release will clear any errors or reminders that are present. If no faults exist, a second quick press will toggle the load voltage between ON/OFF.

- If no errors or reminders are present, one quick press will toggle the load voltage between ON/OFF. The load will not toggle ON/OFF when the unit is in LVD.

- Regardless of the DIP 7 setting, press and hold the push-button for 5 seconds to initiate an Equalization (EQ).

### Lighting Control Mode (DIP 1 ON)

- A quick press and release of the push-button will clear any errors or reminders that are present. A second quick press will then conduct a five minute lighting test. If no errors or reminders are present, the initial press will conduct the lighting test. A lighting test is used to verify correct wiring in the load circuit, and/or verify that the lighting components are operational.
- If no errors or reminders are active, press and hold the push-button for 5 seconds to initiate an EQ.

### Reset ProStar to Factory Settings

To restore factory settings: Disconnect PV; disconnect battery power; press and hold down the push-button; re-start the ProStar by connecting the battery; keep the push-button depressed for 10 secs. A Custom Settings Edit fault will occur - see pp. 58-59 in Section 5 for details. The unit will then need to be re-powered to resume normal operation.

## 4.5 Custom Settings

### 4.5.1 Programming with the Meter Display

The ProStar is available in metered and non-metered versions. The metered model allows:

- Custom programming, including lighting programs, directly from the unit.
- Extensive settings adjustment and information as shown partially in Figure 4-6 below.

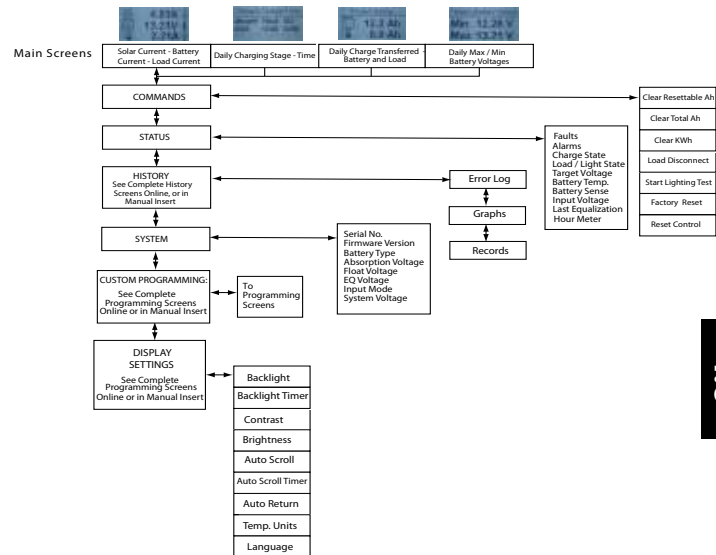

Figure 4-6. Simplified Meter Map.

For metered models, see the included complete meter map insert, also available in the ProStar support documents at:

[www.morningstarcorp.com](http://www.morningstarcorp.com)

### 4.5.2 Programming in MSView

Beyond the preset DIP switch options, the ProStar's charging profile and all other settings are

customizable using MSView PC software available at:

[www.morningstarcorp.com/msview](http://www.morningstarcorp.com/msview)

With a connection to a PC, and to the RJ-11 port of the ProStar, the MSView ProStar Set-up Wizard is capable of editing all charging and lighting parameters, for upload to the controller. The Set-up Wizard, and topics within the Help tab describe programming procedures in detail.

All aspects of connection and programming are covered in the Product Connectivity Manual-Morningstar Communications Document at:

[www.morningstarcorp.com](http://www.morningstarcorp.com)

## 4.5.3 Meter Display Operation

### 4.5.3.1 Directional Key Use and Operation / Navigating the Meter Map

The ProStar's meter map consists of two main axes: The horizontal top level daily monitoring screens, and the vertical Main Menu stacked screens. The four lighted triangular directional control keys allow movement to reach any desired point on the meter map. A lit key indicates a valid direction in the map. The current location is indicated on the display with a column heading, and a bold descriptor.

### 4.5.3.2 Adjusting the Meter Display

The display setting options, as seen in Figure 4-6, are adjustable by using the directional keys to locate and edit a desired setting or variable.

## 4.5.4 Using the Meter Display to Program Charging Set-points, Load Control, Communications, and Advanced Settings

Refer to the complete meter map insert for metered ProStars. From a top level monitoring screens, scroll down to the Main Menu - "Custom Programming" - screen. Select the desired category, and edit the variable or settings as instructed in the meter display. Note that charging set-points should be entered as if for a 12V system - DIP switches 2 and 3 settings prompt the controller to multiply if necessary. See Section 3.2 for configuration details.

The Load Control category includes Normal (load disconnect) and Lighting programming. The Advanced Settings category includes more optional charging, and load control settings.

## 4.5.5 Lighting Control - Programming Overview

The ProStar display has extensive lighting load programmability. With DIP switch 1 ON (up), a dusk-dawn lighting program is enabled, if lighting timing hasn't been programmed in MSView or using the meter; with DIP 1, 4, 5, 6 ON, and the unit programmed, custom timing will be in effect. With DIP 1 OFF (down), all lighting control functions are disabled.

Using either MSView or the meter display, four channels are available for setting timers that can work separately, or in combination. See Section 4.5.6 - Lighting Programming Using the Meter Display - for more details.

#### 4.5.6 Lighting Programming Using the Meter Display

Lighting programming capabilities are accessible with the meter via Custom Programming->Load Control ->Lighting. Lighting settings editing is done via on-screen instructions.

- The Summary provides a graphical representation of the complete lighting configuration
- LVD / LVR can be specified for use when a lighting program is in operation
- Sunrise and Sunset Threshold settings allow the adjustment of percentages of the maximum seen solar array voltage for triggering day and night events.
- There are four channels, each having two timers, which can be used independently, or in combination.
- Events and actions are used as references and controls. An event is one of eight points in a day e.g. sunrise or midnight. Each event can be edited to specify a time offset to trigger an action, which can be, "Do Nothing", "Lights On", or "Lights Off"
- The combination setting of each channel will specify whether the actions and events of each timer will function: not at all (no combination); when both timers' settings match (AND); for either timers' settings (OR).

#### 4.5.7 Low Temperature Foldback

The ProStar MPPT has a Low Temperature Foldback option which can be used to protect lithium batteries from being charged in cold conditions. Custom settings defining the bounds of charge current reduction due to low battery temperature can be programming in MSView, or with the Advanced Custom Settings options with the display interface. Advanced Custom Settings options are available with ProStar MPPT built-in meter models (PS-MPPT-25M and PS-MPPT-40M).

The High Limit defines the lowest temperature at which the controller will deliver 100% of the controller's rated output charging current. The Low Limit defines the temperature at which the controller will stop providing battery charging current. The charge current is tapered linearly from the High Limit to the Low Limit.

**NOTE:** Local meter display setup required for Low Limit < 1° Celsius.

#### ***4.6 Inspection and Maintenance***

---

Table 4-6 below, lists the recommended maintenance schedule to keep your ProStar performing optimally.

Schedule	Maintenance Items
2 weeks after installation	Re-tighten power terminal connections to specified torque values.
3 months after installation	Re-tighten power terminal connections to specified torque values.
Monthly, or After Each Equalization	<p>Inspect the battery bank. Look for cracked or bulging cases, and corroded terminals.</p> <p>For wet cell (flooded type) batteries, make sure the water level is correct. Wet cell water levels should be checked monthly or according to the manufacturer's recommendations.</p>

Table 4-6. Maintenance Schedule (Cont.)

Schedule	Maintenance Items
Annually	<p>Clean the heatsink fins with a clean, dry rag.</p> <p>Inspect all wiring for damage or fraying.</p> <p>Inspect for nesting insects.</p> <p>Re-tighten all wiring terminal connections to specified torque values.</p> <p>Inspect the system earth grounding for all components. Verify all grounding conductors are appropriately secured to earth ground.</p>

Table 4-6. Maintenance Schedule (End)

## 5.0 TROUBLESHOOTING

### 5.1 Alarms

---

#### High Temperature Current Limit

The ProStar will limit the solar input current if the heatsink temperature exceeds safe limits. Solar charge current will be de-rated (to 0 Amps if needed) to reduce the heatsink temperature. The ProStar is designed to operate at full rated current at the maximum rated ambient temperature. This alarm indicates that there is insufficient airflow and that the heatsink temperature is approaching unsafe limits. If the controller frequently reports this alarm condition, corrective action must be taken to provide better air flow or to relocate the controller to a cooler spot.

#### RTS Open

The Remote Temperature Sensor is not connected to the controller. Use of the RTS is recommended for proper battery charging.

#### Heatsink Temperature Sensor Open or Shorted

The heatsink temperature sensor is damaged. Return the controller to an authorized Morningstar dealer for service.

#### Battery Sense Out of Range / Disconnected (only alarm with LED indications)

Battery status LEDs: R/Y - G/Y sequencing. A battery sense wire is disconnected. Inspect the battery sense connections. This alarm is set when the voltage at the battery sense terminals differs by more than five volts from the voltage at the battery terminals.

---

#### Uncalibrated

The controller was not factory calibrated. Return the controller to an authorized Morningstar dealer for service.

### 5.2 LED Fault Indications

---

#### Solar Over-current

Error status LED: Flashing red. Battery status LEDs: R/Y-G sequencing. When the ProStar's rated input current is exceeded, the unit will interrupt array current until current falls below the maximum capacity.

While rare, if array current exceeds approximately 130% of the controller's output current rating, this fault can occur. The fault is generally related to fast, large battery voltage transients (connecting a very heavy or capacitive load like an inverter) that are faster than the controller can regulate and it shuts off to protect the circuitry. The controller will automatically clear the fault, and attempt to re-start in 10 seconds.

#### Load Over-current

Error Status LED: Flashing red. Battery status LEDs: R/Y-G sequencing. If the load current exceeds the maximum load current rating, the ProStar will disconnect the load. The greater the overload, the faster the load will be disconnected. A small overload could take a few minutes to disconnect. The ProStar will attempt to reconnect the load two (2) times. Each attempt is approximately 10 seconds apart. If the overload remains after two (2) attempts, the load will remain disconnected until power is removed and re-applied.

---

### **Solar Short Circuit**

Charging Status LED: OFF. Solar input power wires are short-circuited. Charging automatically resumes when the short is cleared.

### **Battery Reverse Polarity**

No LED indication, the unit is not powered. No damage to the controller will result. Correct the mis-wire to resume normal operation.

### **Load Short Circuit**

Error status LED: Flashing red. Battery status LEDs: R/G-Y sequencing. Fully protected against load wiring short-circuits. After two (2) automatic load reconnect attempts (10 seconds between each attempt) the ProStar will wait, and then automatically reconnect the load, once the short is cleared.

### **High Solar Voltage**

Charging Status LED: R flashing. No battery status indications. If the solar input open-circuit voltage (Voc) exceeds the 60 Volt maximum rating, the array will remain disconnected until the Voc falls safely below the maximum voltage.

### **Remote Temperature Sensor (RTS)**

Error status LED: Flashing red. Battery status LEDs: R/Y - G/Y sequencing. A bad RTS connection or a severed RTS wire has disconnected the temperature sensor during charging. Charging automatically resumes when the problem is fixed. To resume operation without an RTS, disconnect all power to the ProStar and then reconnect. If the controller is re-started with the failure still present, the controller

may not detect that the RTS is connected, and the LEDs will not indicate a fault. A metered model, an RM-1 meter, or MSView PC software can be used to determine if the RTS is working properly.

### **Battery / Load High Voltage disconnect (HVD)**

Error status LED: Flashing red. Battery status LEDs: R-G sequencing. Recovery will occur at HVD re-connect threshold. See Section 7 - Technical Specifications for values.

### **High Heatsink Temperature**

Error status LED: Flashing red. Battery status LEDs: R-Y sequencing. The heatsink temperature has exceeded safe limits. Charging will cease, and the load is disconnected. The load will automatically be reconnected, and charging will resume when the heatsink cools to a safe temperature.

### **Settings (DIP) Switch Changed**

Error status LED: Flashing red. Battery status LEDs: R-Y-G sequencing. If a settings switch is changed while there is power to the controller, the LEDs will begin sequencing and the solar input will be disconnected. The controller must be re-started to clear the fault and begin operation with the new settings.

### **Custom Settings Edit**

Error status LED: Flashing red. Battery status LEDs: R-Y-G sequencing. A value has been modified in custom settings memory. The controller will stop charging and indicate a fault condition. After all settings have been modified, the controller must be



reset by removing and then restoring power to the controller. The new programmed settings will be used after the power reset.

### Firmware Update Failure

The firmware update was not successfully programmed. The controller will not indicate the full power-up LED sequence of G-Y-R when power to the controller is reset. Instead, the controller will display green, and then stop on yellow. The yellow LED will continue to be lit and the controller will not complete start up or begin charging. Re-try the firmware update. The firmware must be successfully loaded before the controller will start up.

### Internal Power Supply Out of Range

Error status LED: Solid red. Battery status LEDs: R-Y-G sequencing. The processor supply voltage is not correct. Contact your Morningstar dealer for service.

### SOLID CHARGING STATUS LED with SELF-TEST (R-Y-G) SOC FAULTS

Verify that nothing has been mis-wired. If not, the error is likely critical. Contact an authorized Morningstar dealer for support.

Fault	Charging Status LED	Battery SOC LEDs
PV FET Short	Solid red	R-Y-G sequencing
Load FET Short	Solid red	R-Y-G sequencing
Load FET Open	Solid red	R-Y-G sequencing
Damaged local temperature sensor	Solid red (only if RTS is invalid)	R-Y-G sequencing
Damaged heatsink temperature sensor	Solid red	R-Y-G sequencing
Software	Solid red	R-Y-G sequencing
Internal power supply out of range	Solid red	R-Y-G sequencing

### RE-SETTABLE SELF-TEST (R-Y-G) SOC FAULTS

Fault	-	Battery SOC LEDs
Custom Settings Edit	-	R-Y-G sequencing
DIP Switch Change	-	R-Y-G sequencing

## **5.3 Battery Charging and Performance Issues**

### **Problem:**

No LED indications, controller does not appear to be powered.

### **Solution:**

With a multi-meter, check the voltage at the battery terminals on the ProStar. Battery voltage must be 10 vdc or greater. If the voltage on the battery terminals of the controller is between 10 and 35 vdc, and no LEDs are lit, contact your authorized Morningstar dealer for service. If no voltage is measured, check wiring connections, fuses, and breakers.

### **Problem:**

The ProStar is not charging the battery.

### **Solution:**

Check the three (3) battery SOC LEDs. If they are flashing in a sequence, see Section 5.2 - LED Fault Indications - of this manual to determine the cause. A metered model, an RM-1 meter, or MSView PC software will display active faults and alarms.

If the LED indications are normal, check the fuses, breakers, and wiring connections in the power source wiring. With a multi-meter, check the array voltage directly at the ProStar solar input terminals. Input voltage must be greater than battery voltage before charging will begin.

### **Problem:**

Controller makes buzzing and humming noises.

### **Solution:**

No action is required. This is expected due to magnetic resonance and circuit switching.

**If troubleshooting does not correct the problem, please refer to Morningstar's Warranty Claim Procedure in Section 6.**

## 6.0 WARRANTY AND POLICIES

### LIMITED WARRANTY Morningstar Solar Controllers and Inverters

The ProStar is warranted to be free from defects in material and workmanship for a period of FIVE (5) years from the date of shipment to the original end user. Morningstar will, at its option, repair or replace any such defective units.

#### WARRANTY EXCLUSIONS AND LIMITATIONS:

This warranty does not apply under the following conditions:

- ◆ Damage by accident, negligence, abuse or improper use
- ◆ PV or load currents exceeding the ratings of the product
- ◆ Unauthorized product modification or attempted repair
- ◆ Damage occurring during shipment
- ◆ Damage results from acts of nature such as lightning and weather extremes

THE WARRANTY AND REMEDIES SET FORTH ABOVE ARE EXCLUSIVE AND IN LIEU OF ALL OTHERS, EXPRESS OR IMPLIED. MORNINGSTAR SPECIFICALLY DISCLAIMS ANY AND ALL IMPLIED WARRANTIES, INCLUDING, WITHOUT LIMITATION, WARRANTIES OF MERCHANTABILITY AND FITNESS FOR A PARTICULAR PURPOSE. NO MORNINGSTAR DISTRIBUTOR, AGENT OR EMPLOYEE IS AUTHORIZED TO MAKE ANY MODIFICATION OR EXTENSION TO THIS WARRANTY.

MORNINGSTAR IS NOT RESPONSIBLE FOR INCIDENTAL OR CONSEQUENTIAL DAMAGES OF ANY KIND, INCLUDING BUT NOT LIMITED TO LOST PROFITS, DOWN-TIME, GOODWILL OR DAMAGE TO EQUIPMENT OR PROPERTY.

R17-8/16

## MORNINGSTAR TECHNICAL SUPPORT POLICIES

Morningstar's Technical Support Group is dedicated to providing unparalleled customer support.

### MS Support Scope:

1. Determining correct or failed functionality of a Morningstar product or system of Morningstar devices. It is expected that owners / operators will use manuals (including trouble shooting sections) before requesting technical support.
2. Providing product warranty replacements in accordance with the terms of Morningstar's warranty policy.
3. Assisting with the operability of all product / system features and functions described in Morningstar manuals and data sheets.

### Please be advised:

- ◆ The Morningstar Technical Support Group generally provides referrals for requested system consultations or design /configuration /sizing services. Distributors, dealers, system designers, installers and vast online resources - including the String Calculator array design tool at [www.morningstarcorp.com](http://www.morningstarcorp.com) - are available to assist in these areas. Morningstar can help refer customers to a nearby authorized distributor, dealer, or installer if assistance is required in designing a renewable energy system that best suits your specific needs.

## MORNINGSTAR TECHNICAL SUPPORT POLICIES (Cont.)

◆ **Please visit the Tech Support section at [www.morningstarcorp.com](http://www.morningstarcorp.com) for any documentation or specification needs before requesting support.**

The site also offers an array sizing tool (String Selector), product comparison tool (Product Comparator) and articles on solar charging technologies and other design considerations.

◆ Although emergencies do arise when a phone call is necessary, e-mail is the best way to contact us, and will result in the quickest response. Please use the support request form Contact Us (preferred), or e-mail us directly at: **[support@morningstarcorp.com](mailto:support@morningstarcorp.com)**

Thank you for your business, and we look forward to assisting you.

## WARRANTY CLAIM PROCEDURE

1. Before proceeding, please refer to product manual, including the Troubleshooting section.
2. Contacting your authorized Morningstar distributor or dealer from whom you purchased the unit is the first step in the warranty process. Local dealers can often address warranty issues quickly.
3. If supplier is unable to address the issue, please contact Morningstar by e-mail (**[support@morningstarcorp.com](mailto:support@morningstarcorp.com)**) with:
  - (A) purchase location - business or company name
  - (B) full model and serial numbers (SN is 8-digits on unit bar label)
  - (C) failure behavior, including LED indications
  - (D) array configuration, panel Pmax, Voc, Vmp, Isc, and nominal battery voltage; these specifications are needed to receive assistance.
  - (E) multi-meter available (for field troubleshooting)
4. After warranty replacement has been approved and new unit(s) received, please return failed unit(s) using pre-paid shipping label, and follow any product specific instructions if requested by Morningstar Warranty Dept.
5. If instructed by Morningstar, after warranty replacement shipment has been received, return of failed unit(s) is required before further warranty replacements can be considered for the original or future cases.

**NOTE: Please do not return units without an RMA or case number. Doing so will increase the time required to resolve your claim.**

## 7.0 TECHNICAL SPECIFICATIONS

PS-15 PS-30  
PS-15M PS-30M

### Electrical:

Nominal Battery voltage 12 or 24 Volts  
 Battery voltage Range 10-35 Volts  
 Voltage accuracy 0.1% +/- 50mV (all)  
 Max. Battery Current 15 Amps 30 Amps  
 Max. PV open-circuit voltage 60 Volts<sup>1</sup>  
 Load Current Rating 15 Amps 30 Amps  
 Self Consumption <22mA (no meter) <40mA (meter)  
 LED Indications (1) status, (3) battery SOC  
 Transient Surge Protection 1500 watts (solar, battery, load)

### Mechanical:

Dimensions: 6.01(W) x 4.14(L) x 2.17(D) in.  
 153(W) x 105(L) x 55(D) mm  
 Weight: 13.8 oz. (no meter)  
 15.1 oz. (meter)

Wire Size Range:  
 Power Terminals 2.5 - 16 mm<sup>2</sup> / #14 - 6 AWG  
 Maximum Torque 35 in-lb  
 Battery/Temp. Sense 0.25 - 1.0 mm<sup>2</sup> / #24 - 16 AWG  
 Enclosure IP20, Type 1

### Battery Charging:

4-Stage Charging: Bulk, Absorption, Float, Equalize  
 Temperature compensation  
 Coefficient: -30mV / °C / 12 Volt  
 Temperature compensated set-points: Absorption, Float, Equalize, HVD

1. Hardware specification - not for design purposes.

Battery Charging Set-points (@ 25°C):  
 [multiply voltages by (2) for 24 Volt systems]

DIP Switch Settings 4-5-6	Battery Type	Absorp. Stage (-olts)	Float Stage (-olts)	Equalize Stage (volts)	Absorp. Time (mins)	Equalize Time (mins)	Equalize Timeout (mins)	Equalize Interval (days)	LVD (volts)	LVR (volts)
off-off-off	1 - Sealed*	14.00	13.50		150				11.50	12.60
off-off-on	2 - Sealed*	14.15	13.50	14.40	150	60	120	28	11.30	12.80
off-on-off	3 - Sealed*	14.30	13.50	14.60	150	60	120	28	11.50	13.00
off-on-on	4 - AGM/Flooded	14.40	13.50	15.10	180	120	180	28	11.70	13.20
on-off-off	5 - Flooded	14.60	13.50	15.30	180	120	180	28	11.90	13.40
on-off-on	6 - Flooded	14.70	13.50	15.40	180	180	240	28	12.10	13.60
on-on-off	7 - L-16	15.40	13.40	16.00	180	180	240	14	12.30	13.80
on-on-on	8 - Custom	Custom	Custom	Custom	Custom	Custom	Custom	Custom	Custom	Custom

\* "Sealed" battery type includes gel and AGM batteries

### Current Compensation:

12 Volt systems -15 mV/A  
 24 Volt systems -30 mV/A  
 Compensated set-points LVD, LVR  
 Compensation threshold 3A

### Load and Solar Control:

[multiply voltages by (2) for 24 Volt systems]:

Default values (customizable)

LVD See table above  
 LVR See table above  
 Instant LVD 10.0V  
 HVD - solar Current stage set-point + 0.5V (@ 25°C)  
 HVD - load 15.3V  
 HVDR - solar 13.8V (@ 25°C)  
 HVDR - load 14.5V  
 LVD Warning 10 mins  
 LVD Override 10 mins  
 Maximum # LVD overrides No limit unless V\_batt < Instant LVD  
 (not customizable)

### Lighting Control (DIP 1 ON):

Lighting Timer Setting	Dusk-Dawn (default)
Lighting Test Timer	5 mins

### Data & Communications:

Communication Port	MeterBus (RJ-11)
Comm. Protocols	Morningstar MeterBus; MODBUS

Data-logging 6-8 months, daily records

PC Software MSView

### Digital Meter:

Resolution	128 x 64 pixels
Viewing Area	50 mm x 25 mm
Display Color	blue on white
Backlight	LED
Operating Temperature	-20°C to +70°C
Storage Temperature	-30°C to +80°C

### Environmental:

Maximum Operating Altitude	2000 meters
Operating Temperature	-40°C to +60°C
Storage Temperature	-40°C to +80°C
Humidity	100% n.c.
Tropicalization	Conformally coated PCBs; Marine-rated terminals

### Protections

---

Power-up against any active faults

Reverse Polarity - battery and array

Solar Short-Circuit

High Solar Voltage

High Heatsink Temperature - Current de-rating

High Heatsink Temperature - Load disconnect

Load Short-Circuit

Load Over-Current

Heatsink Temperature Limit

RTS Terminals

Battery Sense Terminals

PWM Current De-rating

## APPENDIX A - DERATING

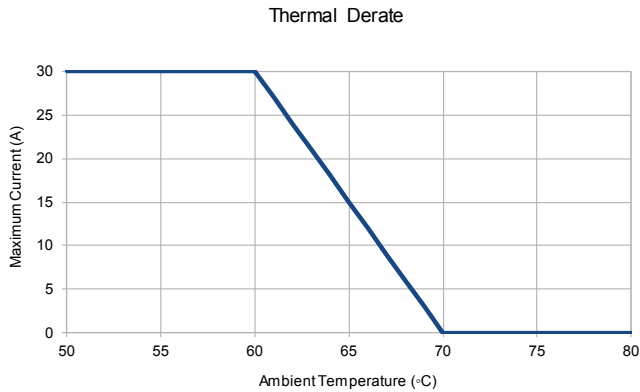

Figure A-1. Maximum Current vs. Ambient Temperature

## APPENDIX B - Wire Sizing

12 Volt Nominal Wire Chart

Amps	One-way Wire Distance (feet) Wire Gauge (AWG)					One-way Wire Distance (meters) Wire Gauge (mm <sup>2</sup> )				
	14	12	10	8	6	2	3	5	8	13
2	70	112	180	287	456	21	32	53	85	139
4	35	56	90	143	228	10	16	26	42	69
6	24	38	60	96	152	7	10	17	28	46
8	18	28	45	72	114	5	8	13	21	34
10	14	23	36	57	91	4	6	10	17	27
12	12	19	30	48	76	3	5	8	14	23
14	10	16	26	41	65	3	4	7	12	19
16	9	14	23	36	57	3	4	7	10	17
18	8	13	20	32	51	2	3	6	9	15
20	7	11	18	29	46	2	3	5	8	13

3% voltage drop, Annealed copper wire at 20°C

24 Volt Nominal Wire Chart

Amps	One-way Wire Distance (feet) Wire Gauge (AWG)					One-way Wire Distance (meters) Wire Gauge (mm <sup>2</sup> )				
	14	12	10	8	6	2	3	5	8	13
2	140	224	360	574	912	42	64	107	171	278
4	70	112	180	286	456	21	32	53	85	139
6	48	76	120	191	304	14	21	35	57	92
8	36	56	90	144	228	10	16	26	42	69
10	29	45	72	115	182	8	12	21	34	55
12	24	38	60	96	152	7	10	17	28	46
14	20	32	51	82	130	6	9	15	24	39
16	18	28	45	72	114	5	8	13	21	34
18	16	25	40	64	101	4	7	11	19	30
20	14	23	36	57	91	4	6	10	17	27

3% voltage drop, Annealed copper wire at 20°C

## APPENDIX C - CERTIFICATIONS



- EN 61000-6-2: 2005/AC:2005 EMC Immunity
- EN 61000-6-4: 2007 +A1:2011 EMC Emissions
- Industry Canada: CAN ICES-3 (B)/NMB-3(B)
- IEC 62109-1: 2010 Safety of Power Converters in PV Systems
- JAS-ANZ Certification
- Restriction of Hazardous Substances Directive 2011/65/EU (RoHS 2)
- Electromagnetic Compatibility Directive 2004/108/EC
- FCC (Title 47 of CFR), Part 15 Subpart B Class B digital device

ProStar™ and MeterBus™ are trademarks of Morningstar Corporation

MODBUS™ and MODBUS TCP/IP™ are trademarks of Modbus IDA. [www.modbus-ida.org](http://www.modbus-ida.org)

© 2020 Morningstar Corporation. All rights reserved.